

Data sheet | Item number: 769-675/003-000

THT male header; 1.0 x 1.0 mm solder pin; angled; clamping collar; Pin spacing 5 mm; 15-pole; gray

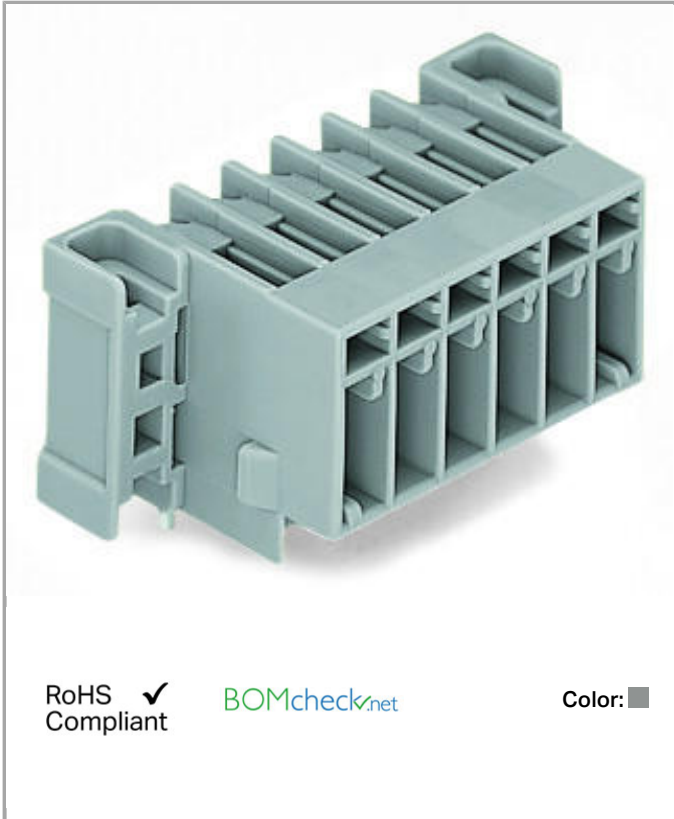

769-675_003-000



RoHS Compliant

[BOMcheck.net](https://www.bomcheck.net)

Color:

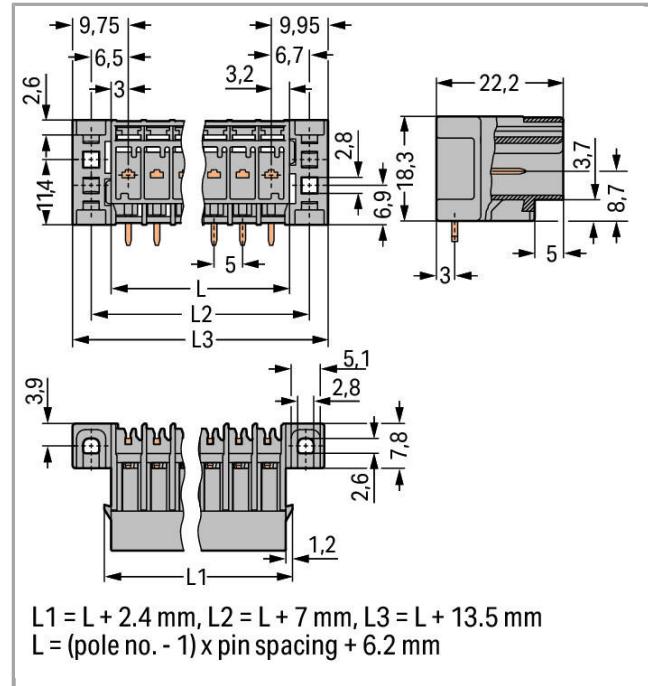

Data

Electrical data

Ratings per IEC/EN 60664-1

Rated voltage (III / 3)	250 V
Rated impulse voltage (III / 3)	4 kV
Rated voltage (III / 2)	500 V
Rated impulse voltage (III / 2)	4 kV
Rated current	32 A

Connection data

Total number of potentials	15
Number of levels	1
No. of poles	15

Geometrical Data

Pin spacing	5 mm / 0.197 inch
Width	89.7 mm / 3.531 inch
Height from the surface	18.3 mm / 0.72 inch
Depth	22.2 mm / 0.874 inch

Mechanical data

Mounting type	Mounting flange
---------------	-----------------

Plug connection

Contact type (pluggable connector)	Male connector/plug
Connector connection type	for PCBs
Mismating protection	No
Mating direction to the PCB	0°

PCB contact

PCB contact	THT
-------------	-----

Material Data

Color	gray
Insulating material	Polyamide 66 (PA 66)
Fire load	0.339 MJ
Weight	16.725 g



Commercial data

Product Group	18 (X-COM-System)
Country of origin	PL
GTIN	4017332427777
Customs Tariff No.	85366990990





Approvals / Certificates

Radio-Approvals



Logo	Approval	Additional Approval Text	Certificate name
	CCA	EN 61984	2190419.02
	CCA	IEC 61984	NL-47799

	CCA DEKRA Certification B.V.	EN 60947	NTR NL-7626
	CSA DEKRA Certification B.V.	C22.2 No. 158	1101144
	KEMA/KEUR DEKRA Certification B.V.	EN 60947	2190419.01



Country specific Approvals

Logo	Approval	Additional Approval Text	Certificate name
	CCA DEKRA Certification B.V.	EN 61984	2190419.02
	CCA DEKRA Certification B.V.	EN 60947	NTR NL-7626
	CCA DEKRA Certification B.V.	IEC 61984	NL-47799
	CSA DEKRA Certification B.V.	C22.2 No. 158	1101144
	KEMA/KEUR DEKRA Certification B.V.	EN 60947	2190419.01

Other Approvals

Logo	Approval	Additional Approval Text	Certificate name
	UR Underwriters Laboratories Inc.	UL 1977	E45171
	UR Underwriters Laboratories Inc.	UL 1059	E45172

UL-Approvals





Logo	Approval	Additional Approval Text	Certificate name
	UR Underwriters Laboratories Inc.	UL 1059	31.07.2019- E45172
	UR Underwriters Laboratories Inc.	UL 1977	E45171- 20010720

Compatible products

Marking accessories

	Item no.: 210-831 Marking strips; on reel; 2.3 mm wide; plain; Self-adhesive; white	210-831
	Item no.: 210-832 Marking strips; on reel; 3 mm wide; plain; Self-adhesive; white	210-832
	Item no.: 210-833 Marking strips; on reel; 6 mm wide; plain; Self-adhesive; white	210-833
	Item no.: 210-834 Marking strips; on reel; 5 mm wide; plain; Self-adhesive; white	210-834

Female plug

	Item no.: 769-101 1-conductor female plug; 4 mm ² ; 1-pole; 4,00 mm ² ; gray	769-101
	Item no.: 769-102 1-conductor female plug; 4 mm ² ; 2-pole; 4,00 mm ² ; gray	769-102
	Item no.: 769-102/000-036 1-conductor female plug; 4 mm ² ; 2-pole; 4,00 mm ² ; gray, green-yellow	769-102 /000-036
	Item no.: 769-102/000-037 1-conductor female plug; 4 mm ² ; 2-pole; 4,00 mm ² ; green-yellow, gray	769-102 /000-037
	Item no.: 769-103 1-conductor female plug; 4 mm ² ; 3-pole; 4,00 mm ² ; gray	769-103
	Item no.: 769-103/000-036 1-conductor female plug; 4 mm ² ; 3-pole; 4,00 mm ² ; gray, green-yellow	769-103 /000-036
	Item no.: 769-103/000-037 1-conductor female plug; 4 mm ² ; 3-pole; 4,00 mm ² ; green-yellow, gray	769-103 /000-037

**Item no.: 769-103/000-038**1-conductor female plug; 4 mm²; 3-pole; 4,00 mm²; gray, blue, green-yellow

/000-038

769-103

**Item no.: 769-103/000-039**1-conductor female plug; 4 mm²; 3-pole; 4,00 mm²; green-yellow, blue, gray

/000-039

769-103

**Item no.: 769-104**1-conductor female plug; 4 mm²; 4-pole; 4,00 mm²; gray

769-104

**Item no.: 769-104/000-036**1-conductor female plug; 4 mm²; 4-pole; 4,00 mm²; gray, green-yellow

/000-036

769-104

**Item no.: 769-104/000-037**1-conductor female plug; 4 mm²; 4-pole; 4,00 mm²; green-yellow, gray

/000-037

769-104

**Item no.: 769-104/000-038**1-conductor female plug; 4 mm²; 4-pole; 4,00 mm²; gray, blue, green-yellow

/000-038

769-104

**Item no.: 769-104/000-039**1-conductor female plug; 4 mm²; 4-pole; 4,00 mm²; green-yellow, blue, gray

/000-039

769-104

**Item no.: 769-105**1-conductor female plug; 4 mm²; 5-pole; 4,00 mm²; gray

769-105

**Item no.: 769-105/000-036**1-conductor female plug; 4 mm²; 5-pole; 4,00 mm²; gray, green-yellow

/000-036

769-105

**Item no.: 769-105/000-037**1-conductor female plug; 4 mm²; 5-pole; 4,00 mm²; green-yellow, gray

/000-037

769-105

**Item no.: 769-105/000-038**1-conductor female plug; 4 mm²; 5-pole; 4,00 mm²; gray, blue, green-yellow

/000-038

769-105

**Item no.: 769-105/000-039**1-conductor female plug; 4 mm²; 5-pole; 4,00 mm²; green-yellow, blue, gray

/000-039

769-105

**Item no.: 769-106**1-conductor female plug; 4 mm²; 6-pole; 4,00 mm²; gray

769-106

**Item no.: 769-106/000-006**1-conductor female plug; 4 mm²; 6-pole; 4,00 mm²; blue















/000-006















769-106

**Item no.: 769-106/000-036**1-conductor female plug; 4 mm²; 6-pole; 4,00 mm²; gray, green-yellow

/000-036

769-106

	Item no.: 769-106/000-037 1-conductor female plug; 4 mm ² ; 6-pole; 4,00 mm ² ; green-yellow, gray	/000-037	769-106
	Item no.: 769-106/000-038 1-conductor female plug; 4 mm ² ; 6-pole; 4,00 mm ² ; gray, blue, green-yellow	/000-038	769-106
	Item no.: 769-106/000-039 1-conductor female plug; 4 mm ² ; 6-pole; 4,00 mm ² ; green-yellow, blue, gray	/000-039	769-106
	Item no.: 769-107 1-conductor female plug; 4 mm ² ; 7-pole; 4,00 mm ² ; gray		769-107
	Item no.: 769-107/000-036 1-conductor female plug; 4 mm ² ; 7-pole; 4,00 mm ² ; gray, green-yellow	/000-036	769-107
	Item no.: 769-107/000-037 1-conductor female plug; 4 mm ² ; 7-pole; 4,00 mm ² ; green-yellow, gray	/000-037	769-107
	Item no.: 769-107/000-038 1-conductor female plug; 4 mm ² ; 7-pole; 4,00 mm ² ; gray, blue, green-yellow	/000-038	769-107
	Item no.: 769-107/000-039 1-conductor female plug; 4 mm ² ; 7-pole; 4,00 mm ² ; green-yellow, blue, gray	/000-039	769-107
	Item no.: 769-108 1-conductor female plug; 4 mm ² ; 8-pole; 4,00 mm ² ; gray		769-108
	Item no.: 769-108/000-036 1-conductor female plug; 4 mm ² ; 8-pole; 4,00 mm ² ; gray, green-yellow	/000-036	769-108
	Item no.: 769-108/000-037 1-conductor female plug; 4 mm ² ; 8-pole; 4,00 mm ² ; green-yellow, gray	/000-037	769-108
	Item no.: 769-108/000-038 1-conductor female plug; 4 mm ² ; 8-pole; 4,00 mm ² ; gray, blue, green-yellow	/000-038	769-108
	Item no.: 769-108/000-039 1-conductor female plug; 4 mm ² ; 8-pole; 4,00 mm ² ; green-yellow, blue, gray	/000-039	769-108
	Item no.: 769-109 1-conductor female plug; 4 mm ² ; 9-pole; 4,00 mm ² ; gray		769-109
	Item no.: 769-109/000-036 1-conductor female plug; 4 mm ² ; 9-pole; 4,00 mm ² ; gray, green-yellow	/000-036	769-109

	Item no.: 769-109/000-037 1-conductor female plug; 4 mm ² ; 9-pole; 4,00 mm ² ; green-yellow, gray	/000-037	769-109
	Item no.: 769-109/000-038 1-conductor female plug; 4 mm ² ; 9-pole; 4,00 mm ² ; gray, blue, green-yellow	/000-038	769-109
	Item no.: 769-109/000-039 1-conductor female plug; 4 mm ² ; 9-pole; 4,00 mm ² ; green-yellow, blue, gray	/000-039	769-109
	Item no.: 769-110 1-conductor female plug; 4 mm ² ; 10-pole; 4,00 mm ² ; gray		769-110
	Item no.: 769-110/000-036 1-conductor female plug; 4 mm ² ; 10-pole; 4,00 mm ² ; gray, green-yellow	/000-036	769-110
	Item no.: 769-110/000-037 1-conductor female plug; 4 mm ² ; 10-pole; 4,00 mm ² ; green-yellow, gray	/000-037	769-110
	Item no.: 769-110/000-038 1-conductor female plug; 4 mm ² ; 10-pole; 4,00 mm ² ; gray, blue, green-yellow	/000-038	769-110
	Item no.: 769-110/000-039 1-conductor female plug; 4 mm ² ; 10-pole; 4,00 mm ² ; green-yellow, blue, gray	/000-039	769-110
	Item no.: 769-111 1-conductor female plug; 4 mm ² ; 11-pole; 4,00 mm ² ; gray		769-111
	Item no.: 769-111/000-036 1-conductor female plug; 4 mm ² ; 11-pole; 4,00 mm ² ; gray, green-yellow	/000-036	769-111
	Item no.: 769-111/000-037 1-conductor female plug; 4 mm ² ; 11-pole; 4,00 mm ² ; green-yellow, gray	/000-037	769-111
	Item no.: 769-111/000-038 1-conductor female plug; 4 mm ² ; 11-pole; 4,00 mm ² ; gray, blue, green-yellow	/000-038	769-111
	Item no.: 769-111/000-039 1-conductor female plug; 4 mm ² ; 11-pole; 4,00 mm ² ; green-yellow, blue, gray	/000-039	769-111
	Item no.: 769-112 1-conductor female plug; 4 mm ² ; 12-pole; 4,00 mm ² ; gray		769-112
	Item no.: 769-112/000-036 1-conductor female plug; 4 mm ² ; 12-pole; 4,00 mm ² ; gray, green-yellow	/000-036	769-112
	Item no.: 769-112/000-037 1-conductor female plug; 4 mm ² ; 12-pole; 4,00 mm ² ; green-yellow, gray	/000-037	769-112

**Item no.: 769-112/000-038**1-conductor female plug; 4 mm²; 12-pole; 4,00 mm²; gray, blue, green-yellow

/000-038

769-112

**Item no.: 769-112/000-039**1-conductor female plug; 4 mm²; 12-pole; 4,00 mm²; green-yellow, blue, gray

/000-039

769-112

**Item no.: 769-113**1-conductor female plug; 4 mm²; 13-pole; 4,00 mm²; gray

769-113

**Item no.: 769-113/000-036**1-conductor female plug; 4 mm²; 13-pole; 4,00 mm²; gray, green-yellow

/000-036

769-113

**Item no.: 769-113/000-037**1-conductor female plug; 4 mm²; 13-pole; 4,00 mm²; green-yellow, gray

/000-037

769-113

**Item no.: 769-113/000-038**1-conductor female plug; 4 mm²; 13-pole; 4,00 mm²; gray, blue, green-yellow

/000-038

769-113

**Item no.: 769-113/000-039**1-conductor female plug; 4 mm²; 13-pole; 4,00 mm²; green-yellow, blue, gray

/000-039

769-113

**Item no.: 769-114**1-conductor female plug; 4 mm²; 14-pole; 4,00 mm²; gray

769-114

**Item no.: 769-114/000-036**1-conductor female plug; 4 mm²; 14-pole; 4,00 mm²; gray, green-yellow

/000-036

769-114

**Item no.: 769-114/000-037**1-conductor female plug; 4 mm²; 14-pole; 4,00 mm²; green-yellow, gray

/000-037

769-114

**Item no.: 769-114/000-038**1-conductor female plug; 4 mm²; 14-pole; 4,00 mm²; gray, blue, green-yellow

/000-038

769-114

**Item no.: 769-114/000-039**1-conductor female plug; 4 mm²; 14-pole; 4,00 mm²; green-yellow, blue, gray

/000-039

769-114

**Item no.: 769-115**1-conductor female plug; 4 mm²; 15-pole; 4,00 mm²; gray

769-115

**Item no.: 769-115/000-036**1-conductor female plug; 4 mm²; 15-pole; 4,00 mm²; gray, green-yellow



















/000-036

769-115

**Item no.: 769-115/000-037**1-conductor female plug; 4 mm²; 15-pole; 4,00 mm²; green-yellow, gray

/000-037

769-115

	Item no.: 769-115/000-038 1-conductor female plug; 4 mm ² ; 15-pole; 4,00 mm ² ; gray, blue, green-yellow	769-115
		7000-038
	Item no.: 769-115/000-039 1-conductor female plug; 4 mm ² ; 15-pole; 4,00 mm ² ; green-yellow, blue, gray	769-115
		7000-039
	Item no.: 769-115/021-000 1-conductor female plug; Locking lever; 4 mm ² ; 15-pole; 4,00 mm ² ; gray	769-115
		7021-000
	Item no.: 769-121 2-conductor female connector; 4 mm ² ; 1-pole; 4,00 mm ² ; gray	769-121
	Item no.: 769-122 2-conductor female connector; 4 mm ² ; 2-pole; 4,00 mm ² ; gray	769-122
	Item no.: 769-123 2-conductor female connector; 4 mm ² ; 3-pole; 4,00 mm ² ; gray	769-123
	Item no.: 769-124 2-conductor female connector; 4 mm ² ; 4-pole; 4,00 mm ² ; gray	769-124
	Item no.: 769-125 2-conductor female connector; 4 mm ² ; 5-pole; 4,00 mm ² ; gray	769-125
	Item no.: 769-126 2-conductor female connector; 4 mm ² ; 6-pole; 4,00 mm ² ; gray	769-126
	Item no.: 769-127 2-conductor female connector; 4 mm ² ; 7-pole; 4,00 mm ² ; gray	769-127
	Item no.: 769-128 2-conductor female connector; 4 mm ² ; 8-pole; 4,00 mm ² ; gray	769-128
	Item no.: 769-129 2-conductor female connector; 4 mm ² ; 9-pole; 4,00 mm ² ; gray	769-129
	Item no.: 769-130 2-conductor female connector; 4 mm ² ; 10-pole; 4,00 mm ² ; gray	769-130
	Item no.: 769-131 2-conductor female connector; 4 mm ² ; 11-pole; 4,00 mm ² ; gray	769-131
	Item no.: 769-132 2-conductor female connector; 4 mm ² ; 12-pole; 4,00 mm ² ; gray	769-132
	Item no.: 769-133 2-conductor female connector; 4 mm ² ; 13-pole; 4,00 mm ² ; gray	769-133
	Item no.: 769-134 2-conductor female connector; 4 mm ² ; 14-pole; 4,00 mm ² ; gray	769-134
	Item no.: 769-135 2-conductor female connector; 4 mm ² ; 15-pole; 4,00 mm ² ; gray	769-135

Coding





Item no.: 769-435

769-435

Coding pin; for coding of female plugs; for carrier terminal blocks / male connectors; orange

ferrule

	Item no.: 216-101 Ferrule; Sleeve for 0.5 mm ² / AWG 22; uninsulated; electro-tin plated	216-101
	Item no.: 216-102 Ferrule; Sleeve for 0.75 mm ² / AWG 20; uninsulated; electro-tin plated	216-102
	Item no.: 216-103 Ferrule; Sleeve for 1 mm ² / AWG 18; uninsulated; electro-tin plated	216-103
	Item no.: 216-104 Ferrule; Sleeve for 1.5 mm ² / AWG 16; uninsulated; electro-tin plated	216-104
	Item no.: 216-201 Ferrule; Sleeve for 0.5 mm ² / 20 AWG; insulated; electro-tin plated; white	216-201
	Item no.: 216-202 Ferrule; Sleeve for 0.75 mm ² / 18 AWG; insulated; electro-tin plated; gray	216-202
	Item no.: 216-203 Ferrule; Sleeve for 1 mm ² / AWG 18; insulated; electro-tin plated; red	216-203
	Item no.: 216-204 Ferrule; Sleeve for 1.5 mm ² / AWG 16; insulated; electro-tin plated; black	216-204
	Item no.: 216-206 Ferrule; Sleeve for 2.5 mm ² / AWG 14; insulated; electro-tin plated; blue	216-206
	Item no.: 216-301 Ferrule; Sleeve for 0.25 mm ² / AWG 24; insulated; electro-tin plated; yellow	216-301
	Item no.: 216-302 Ferrule; Sleeve for 0.34 mm ² / 22 AWG; insulated; electro-tin plated; green	216-302

Downloads

Documentation

Bid Text

769-675/003-000		doc 25.6 kB	Download
-----------------	--	----------------	----------

Additional Information

Technical explanations	Apr 3, 2019	pdf 2.1 MB	Download
------------------------	-------------	---------------	----------

CAD/CAE - Smart Data

CAD data

3D Download 769-675/003-000		URL	Download
-----------------------------	--	-----	----------



Product family

X-COM

Show all products from the family

Subject to changes.
